

Electromagnetic Lock Installation User Guide (In-door Models)

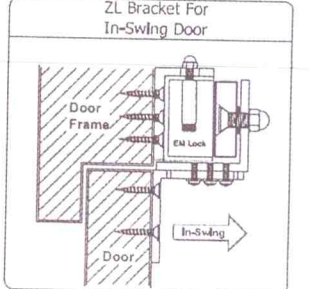

Spec/Model	300-S	300-LED**	600-S	600-LED	1200-S	1200-LED
Holding	300lbs(136kg)	300lbs(136kg)	600lbs(272kg)	600lbs(272kg)	1200lbs(545kg)	1200lbs(545kg)
Voltage Input	12/24 VDC	12/24 VDC	12/24VDC	12/24 VDC	12/24 VDC	12/24VDC
Current Draw	300/150mA	300/150mA	480/240mA	480/240mA	420/210mA	420/210mA

Basic Installation Concept & Accessories

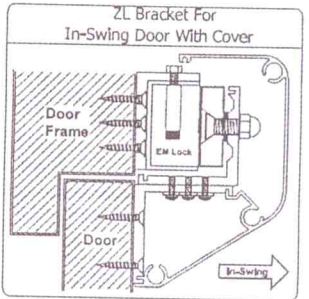
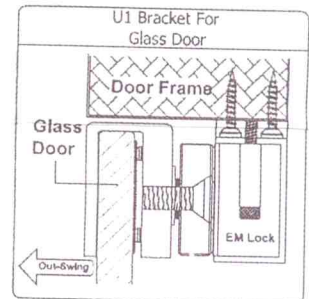
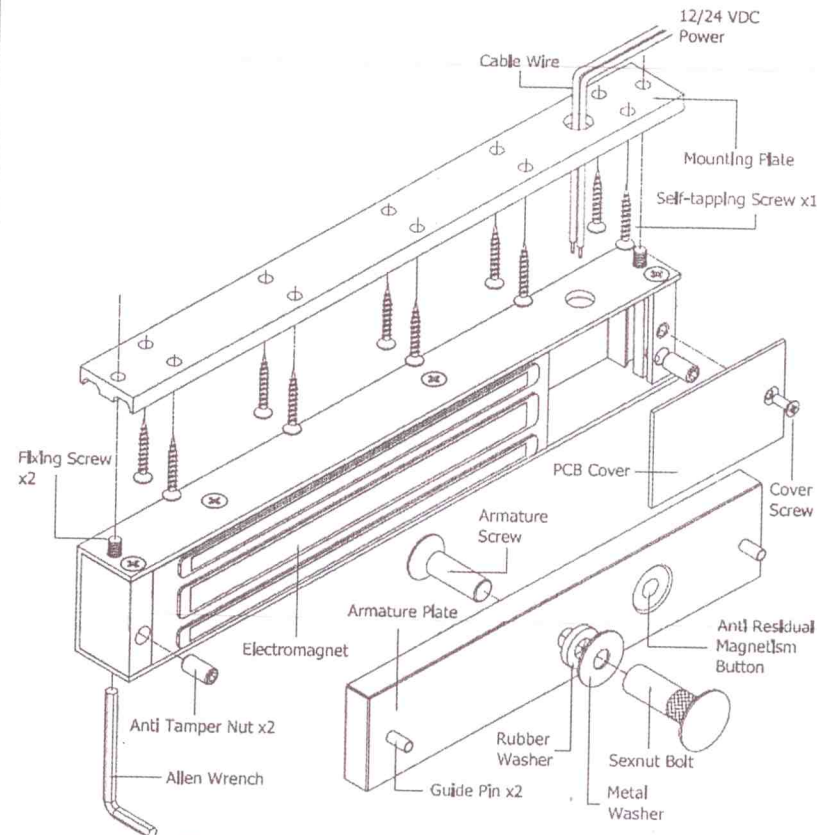
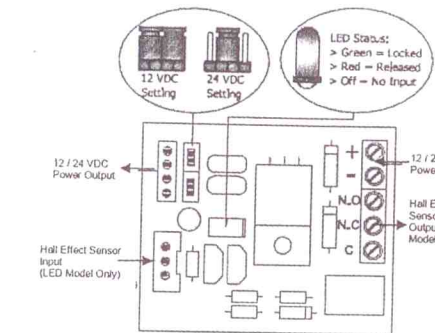
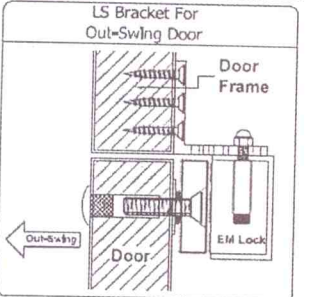
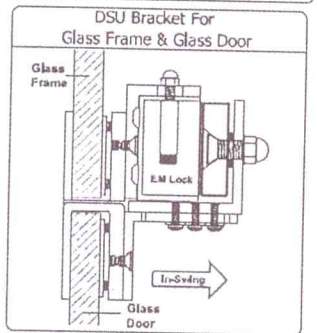
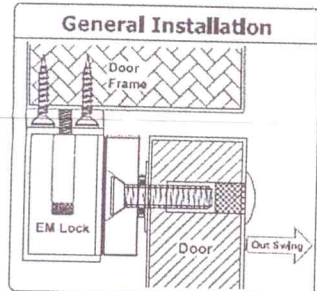

General Installation Steps & Maintenance

1. Drill the armature plate holes in the door using the sticker template provided.
2. Attach the armature plate to the door with the hardware provided per the illustration.
3. With the door closed, mark the door frame at the edge of the armature in order to properly align the electromagnet to the armature.
4. Attach the mounting plate to the door frame using the self-tapping screws provided. Align the mounting plate with the mark from the previous instruction.
5. Insert the wires through the hole in the mounting plate and into the electromagnet unit. Attach the electromagnet unit to the mounting plate with the allen head fixing screw.
6. Screw in the anti-tamper nuts to prevent unauthorized access and prevent the fixing screw from loosening over time.
7. Connect the power wires according to the instruction and test the system.
8. It is recommended that you apply a light coat of silicon lubricant to the mating surface on a monthly basis to prevent rust.

Trouble Shooting

- A) Sensor not functioning -**
- Improper attachment of electromagnet and armature.
 - Modification of the PCB
- B) Door not locked -**
- Incorrect wiring or no power from power supply
- C) Reduced holding force -**
- Poor contact of electromagnet and armature. Be sure armature is loose enough that it can fully contact electromagnet along the entire length.
 - Mating surface in dusty or damaged.
 - Improper input voltage or wire size.

** Model Not Listed In UL